

GAS PRESSURE REGULATOR & MODULATOR CATALOG

6th Edition



MAXITROL®

www.maxitrol.com

▲ WARNING

Service and installation must be performed by a trained/experienced service technician.

All products used with combustible gas **must** be installed and used **strictly** in accordance with the instructions of the Original Equipment Manufacturer (OEM) and with all applicable government codes and regulations, e.g. plumbing, mechanical, and electrical codes and practices. Maxitrol products should be installed and operated in accordance with Maxitrol Safety Warning Instructions.

Maxitrol Company is NOT responsible for any errors or omissions in reliance by anyone of any information set forth in this catalog without additional reference to local requirements and applicable ordinances or codes.

Other worldwide approvals and certifications available upon inquiry.



RV SERIES

Rubber Seat Poppet Design

The compact RV poppet regulators are designed primarily for main burner and pilot load applications. Typical applications include residential and commercial cooking appliances, barbecues, hearth products, and pilot lines. Maxitrol rubber seat poppet models offer the ultimate in design features and performance capabilities to meet your specific appliance or utility requirements.

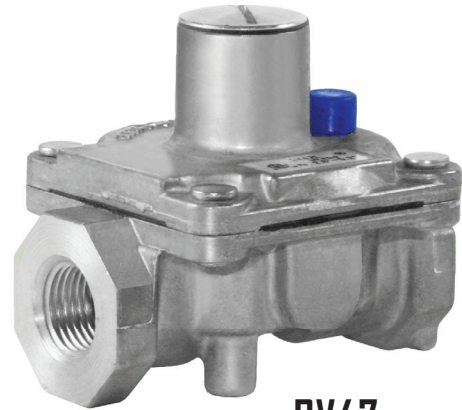

RV47

Specifications

- Pipe Sizes** 1/8" thru 3/4" threaded connections with NPT or ISO 7-1 threads.
(Other connections available, please consult Maxitrol Company.)
- Housing Material** RV12, RV20, RV47, RV48, CV47, CV48: aluminum.
- Mounting** All models, with the exception of "D" suffix models, are suitable for multi-positional mounting. Other than upright position will result in a slight difference in outlet pressure. "D" suffix models are to be mounted upright only. For the RV48, if a **vLimiter**[®] or **vProtector**[®] is installed, mount in an upright horizontal position only. The **vLimiter**[®] 12A06 is multi-positional.
- NOTE:** All Maxitrol gas pressure regulators should be installed and operated in accordance with Maxitrol Safety Warning Instructions (see GPR_MI_EN.ES or GPR_CSA_MI_EN.FR).
- Certifications** RV Series: ANSI Z21.18/CSA 6.3 Gas Appliance Pressure Regulators.
CV47 and CV48 Series: ANSI Z21.78/CSA 6.20 Combination Gas Controls for Gas Appliances.
- Fuel Gases (RV Series)** Suitable for natural, manufactured, mixed gases, liquefied petroleum gases, and LP gas-air mixtures.
- Fuel Gases (CV47 Series)** Suitable for natural or liquefied petroleum gases.
- Rated Inlet Pressure** 1/2 psi (3.4 kPa)
- Emergency Exposure Limits** 2.5 psi (17.2 kPa)
- Ambient Temperature Ranges**... RV20, RV47, RV48, CV47, CV48: 32° to 225°F (0° to 107°C)
RV12: -40 to 225°F (-40 to 107°C)
RV12T: -40 to 275°F (-40 to 135°C)
RV20T: -40 to 300°F (-40 to 148°C)
RV48T: 32 to 275°F (0 to 135°C)
RV47T2, RV48T2: -40 to 225°F (-40 to 107°C)
- Minimum Regulation**..... Suitable for pilot flow applications. **(P)** (Circle P) (0.15 CFH NG), **(Δ)** (Delta P) (0.50 CFH NG), None (1.5 CFH NG), N Models (3 CFH NG).



Model Designations

Models having a suffix letter or a combination of suffix letters listed below indicates the design modifications described.

- A** Limited spring adjustment (RV47A & CV47A*, short stack**).
 - C** Convertible regulators***; preset to deliver outlet pressures for either natural or LP gases.
(RV20, RV47, RV48, CV47, CV48)
 - D** Integral ball check limiting device; permits higher maximum individual load (RV47).
(see Capacities and Pressure Drop, page 6)
 - E** Excessive pressure rated.
 - F** Factory-set; fixed/non-adjustable regulator.
 - I** Left side integral manual valve; outlet faces main inlet (CV47).
 - L** Integral vent limiting orifice as the breather hole - with dust cap.
 - M** B.S.P. - PL parallel thread - conforms to ISO 7-1, where pressure tight joints are made on the threads.
 - N** Internal by-pass orifice to prevent lockup. Main burner only (RV20, RV47, RV48, CV47).
 - R** Right side+ integral manual valve; outlet faces main outlet (CV47).
 - SR** Side outlet pressure plugged tap; right side+ 1/8" NPT (RV20, RV47, RV48, CV47I).
 - S** Side outlet pressure plugged tap; left side+ 1/8" NPT (RV20, RV47, RV48, CV47R).
 - T** Higher ambient temperature range.
 - T2** Lower minimum ambient temperature (RV47, RV48).
 - V** Threaded vent connector, 5/16-24 for 1/8" tubing connection (RV20) - with dust cap.
- * CV47 and CV48 are best described as an RV47 and RV48 with an extra regulated outlet. This outlet contains an integral manual valve located on the valve body's side.
 - ** Short stack models have an adjustment range of less than 2" w.c. (0.5 kPa); these models are advantageous where installation must be made in a limited space.
 - *** Convertible regulators are designed to deliver either of two fixed outlet pressures for natural or LP gases.
RV20C: NAT GAS: 4.0" w.c. (1.0 kPa); LP: 10" w.c. (2.5 kPa)
RV47C, RV48C, CV47C, CV48C: NAT GAS: 4.0", 5.0" or 6.0" w.c. (1.0, 1.3, or 1.5 kPa); LP: 10" or 11" w.c. (2.5 or 2.8 kPa) for residential ranges. Other settings may be available as standards allow.
 - + Left and right is determined when viewing regulator from outlet side with stack up.

NOTE: For the RV48 and RV20V vent accessory options, see page 62.

RV SERIES

Rubber Seat Poppet Design

Capacities and Pressure Drop

Capacities expressed in Btu/h (m³/h) @ 0.64 sp gr gas

Model	Pipe Size	Pressure Drop @ 0.3" w.c. or (0.07 kPa)	Range of Regulation		Individual Load	
			Main Burner	Main Burner & Pilot	Fixed Orifice	Ball Check Device
RV12	1/8" x 1/8"*	14,800 (0.42)	30,000 (0.85)	25,000 (0.71)	20,000 (0.56)	---
	3/16" x 3/16"Loxit	8,800 (0.25)		15,000 (0.43)		
RV20	1/4" x 1/4" 3/8" x 3/8"*	30,000 (0.85)	65,000 (1.84)	50,000 (1.4)	30,000 (0.85)	---
RV20C	1/4" x 1/4" 3/8" x 3/8"	30,000 (0.85)	75,000 (2.11)	50,000 (1.4)	15,000 (0.42)	---
CV47 RV47	3/8" x 3/8"	55,000 (1.5)	125,000 (3.5)	90,000 (2.5)	40,000 (1.1)	125,000 (3.5)
	1/2" x 1/2"*	60,000 (1.7)				
CV47A or C RV47A or C	3/8" x 3/8"	55,000 (1.5)	125,000 (3.5)	125,000 (3.5)	40,000 (1.1)	125,000 (3.5)
	1/2" x 1/2"	60,000 (1.7)				
CV48 RV48	1/2" x 1/2"	130,000 (3.7)	230,000 (6.5)	230,000 (6.5)	40,000 (1.1)	160,000 (4.5)
	3/4" x 3/4"	150,000 (4.2)	250,000 (7.1)	250,000 (7.1)		
CV48C RV48C	1/2" x 1/2"	130,000 (3.7)	400,000 (11.3)	275,000 (7.8) Nat	40,000 (1.1)	160,000 (4.5)
	3/4" x 3/4"	150,000 (4.2)		275,000 (3.1) LP		

*Also available as Loxit connection.

NOTE: CSA maximum capacities vary with spring range and pipe size. Please contact Maxitrol directly for CSA maximums. Minimum main burner regulation capacity for all models (except "N") is 150 Btu/hr (0.0042 m³/h). See pages 58-59 for Regulator Sizing Requirements and Examples.

Spring Selection Chart: inches w.c. (kPa)

Model	Available Springs										
RV12	1.5 to 3* (0.37 to 0.75) Brown	2.8 to 5.2 (0.69 to 1.3) Plated	---	4 to 8 (1 to 2) Orange	---	---	---	---	6 to 10 (1.5 to 2.5) Red	8 to 12 (2 to 3) Blue	---
RV20	1 to 3.5* (0.25 to 0.9) Brown	2.8 to 5.2 (0.69 to 1.3) Plated	---	4 to 8 (1 to 2) Orange	---	---	---	---	6 to 10 (1.5 to 2.5) Red	8 to 12 (2 to 3) Blue	9 to 12** (2.25 to 3) Plated
CV47 RV47	1 to 3.5* (0.25 to 0.9) Brown	2.8 to 5.2 (0.69 to 1.3) Plated	3.8 to 4.3 (0.95 to 1.08) Black	4 to 8 (1 to 2) Orange	4 to 12* (1 to 3) Violet	4.7 to 5.3 (1.18 to 1.33) Green	---	5.6 to 6.4 (1.4 to 1.6) Red	6 to 10 (1.5 to 2.5) Red	8 to 12 (2 to 3) Blue	9.7 to 11.3 (2.42 to 2.83) Plated
CV48 RV48	1 to 3.5* (0.25 to 0.9) Brown	3.0 to 6.0 (0.75 to 1.5) Plated	---	4 to 8 (1 to 2) Orange	---	---	5 to 12 (1.25 to 3) Blue	---	6 to 10 (1.5 to 2.5) Red	---	---

*Uncertified Spring

**Certified at inlet pressure of 2 psi

Model	Available Springs					
RV20CL	4 / 10 (1 / 2.5)	---	---	---	---	---
CV47CL*** RV47CL***	4 / 10 (1 / 2.5)	4 / 11 (1 / 2.75)	5 / 10 (1.25 / 2.5)	5 / 11 (1.25 / 2.75)	6 / 10 (1.5 / 2.5)	6 / 11 (1.5 / 2.75)
CV48C RV48C(L)***	4 / 10 (1 / 2.5)	4 / 11 (1 / 2.75)	5 / 10 (1.25 / 2.5)	5 / 11 (1.25 / 2.75)	6 / 10 (1.5 / 2.5)	6 / 11 (1.5 / 2.75)

***Listed spring ranges are for residential ranges. Other settings may be available as standards allow.

NOTE: See pages 56-57 for complete Spring Selection Chart.

RV SERIES

Rubber Seat Poppet Design

Dimensions

Model	Pipe Size	Vent	Swing Radius	Dimensions			
				A	B	C	D
RV12	1/8" 3/16" Loxit	Integral Vent Limiting Orifice "L"	1.4" (35 mm)	1.7" (43 mm)	0.4" (10 mm)	1.7" (43 mm)	1.4" (35 mm)
RV20	1/4", 3/8"	Integral Vent Limiting Orifice "L" or 5/16-24 "V"	1.6" (41 mm)	2.1" (54 mm)	0.5" (13 mm)	2.4" (61 mm)	1.8" (45 mm)
CV47 RV47	3/8", 1/2"	Integral Vent Limiting Orifice "D" or "L" suffix	1.9" (48 mm)	2.5" (64 mm)	0.6" (16 mm)	2.9" (75 mm)	2.3" (57 mm)
CV47A RV47A			1.6" (41 mm)	2.3" (57 mm)			
CV48 RV48	1/2", 3/4"	Integral "L" or 1/8" NPT, 12A04 or 12A06 vent limiting device	2" (51 mm)	2.8" (70 mm)	0.8" (19 mm)	3.4" (86 mm)	3" (76 mm)

NOTE: Dimensions are maximums and to be used only as an aid in designing clearance for the valve.
Actual production dimensions may vary somewhat from those shown.

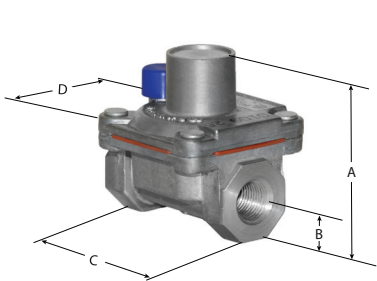

RV12

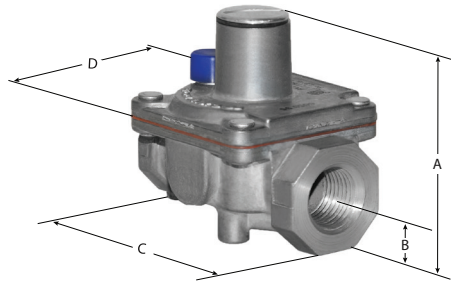

RV20

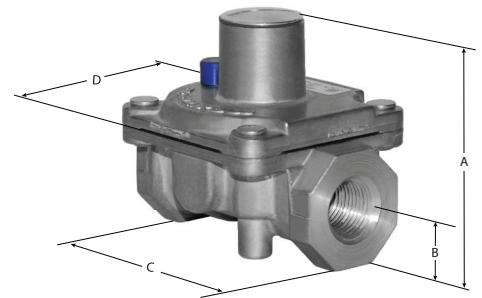

RV47, RV47A

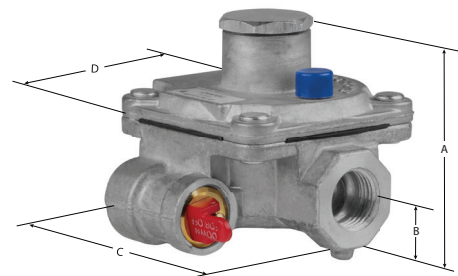

CV47, CV47A

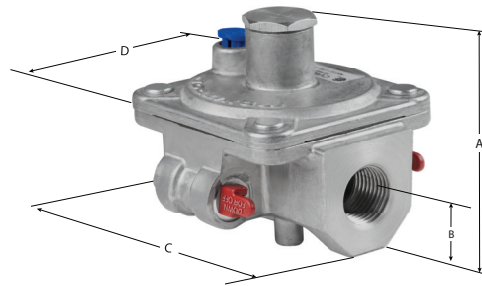

CV48

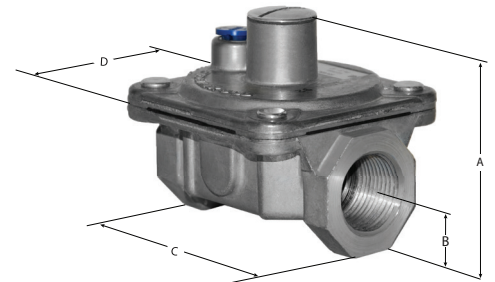

RV48

Rubber Seat Poppet Design

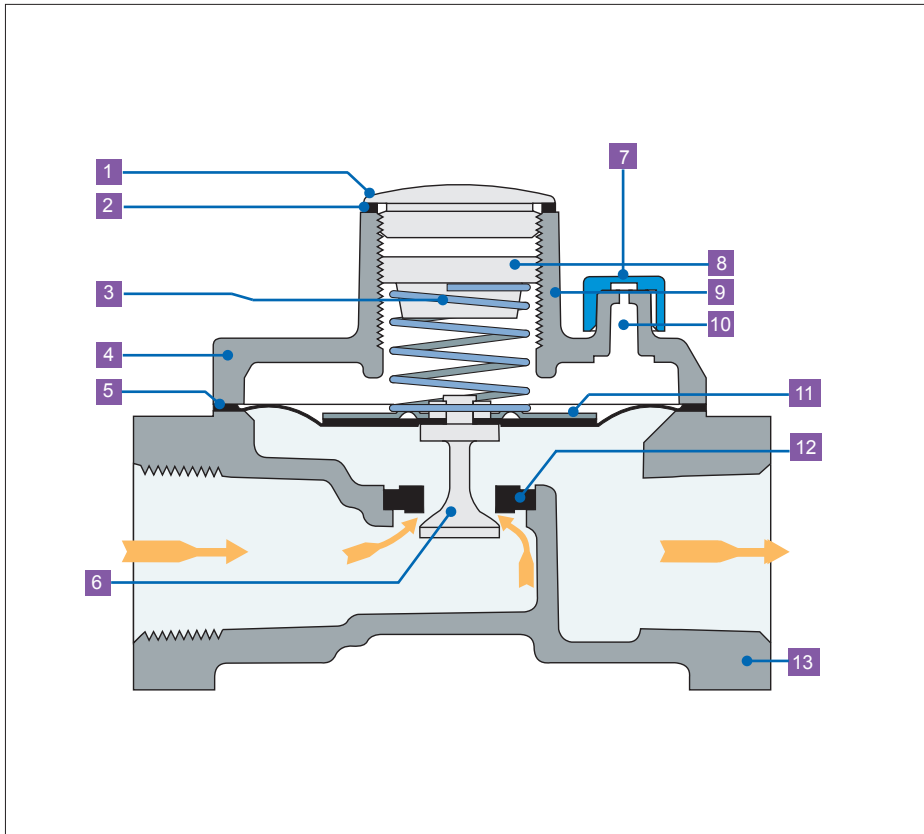

- 1** Welch Plug or Seal Cap
- 2** Seal Cap Gasket
- 3** Spring
- 4** Top Housing
- 5** Diaphragm
- 6** Stem & Valve
- 7** Dust Cap
- 8** Adjusting Screw
- 9** Stack
- 10** Vent
- 11** Diaphragm Plate
- 12** Rubber Seat
- 13** Bottom Housing

NOTE: Diagrams are graphical representations only and may differ from actual product.

SIZING A REGULATOR

See www.maxitrol.com for our Regulator Sizing Program. Please contact Maxitrol directly for more information on sizing a regulator.

System Requirements

When sizing a regulator the following must be known:

- Gas Type
- Available Inlet Pressure
- Desired Outlet Pressure
- Zero Governor Application (indicated by model number ending in "Z")
- Will the regulator control main burner and pilot load OR main burner only?
- Required minimum and maximum flow rate in cfh or m³/h or Btu/h
- Pipe Size

In most cases, the manifold pipe size has already been selected on the basis of good engineering practice, and the regulator pipe size should conform to this size.

The capacity of any regulator is not an absolute value but will vary with the application depending on the prevailing differential pressure.

⚠ WARNING

Service and installation must be performed by a trained/experienced service technician.

All products used with combustible gas must be installed and used strictly in accordance with the instructions of the Original Equipment Manufacturer (OEM) and with all applicable government codes and regulations, e.g. plumbing, mechanical, and electrical codes and practices. These instructions do NOT supersede OEM's installation or operating instructions.

All Maxitrol products should be installed and operated in accordance with Maxitrol Safety Warning Instructions.

HOW TO CALCULATE PRESSURE DROP AT VARIOUS FLOW RATES FROM CAPACITY CHART

LP Applications - When using natural gas pressure drop chart to determine LP pressure drop in terms of Btu/h, multiply NAT Btu/h by 1.61; in terms of CFH multiply NAT CFH by 0.645.

$$\text{Formula: } P_2 = P_1 \times (Q_2/Q_1)^2$$

P2 = Pressure drop at desired flow rate
P1 = Known pressure drop

Q2 = Desired flow rate
Q1 = Known flow rate

A. Check Capacity Chart, ensuring regulator has ample range of regulation and individual load capacities (for use with pilot) for the application.

B. Know the minimum encountered inlet pressure. MINIMUM INLET PRESSURE MINUS "P2" MUST BE GREATER THAN DESIRED OUTLET PRESSURE. Solve for "P2" using the formula above. (See examples on page 59.)

Sizing Examples

RUBBER SEAT POPPETS

For main burner and pilot load applications.

Example: To select an RV type regulator:

- Known: Single 150,000 Btu/h main burner; pipe size 1/2"; inlet pressure 7" w.c.; outlet pressure 4" w.c.
- Solution: The RV48 (1/2") has a maximum capacity of 230,000 Btu/h and a maximum individual load of 160,000 Btu/h. The pressure drop at a flow rate of 150,000 Btu/h is 0.4" w.c., well below the available differential of 3" w.c. The RV48 (without "L" fixed orifice) is the correct regulator to use for the application.

STRAIGHT-THRU-FLOW (S-T-F)

For main burner only applications not requiring a lockup type regulator. When sizing the S-T-F series, it is recommended that pressure drop not exceed 1/2 of available differential pressure.

Example: To select an RV type regulator:

- Known: Flow rate 2,000,000 Btu/h; pipe size 1 1/4"; inlet pressure 9" w.c.; outlet pressure 5" w.c.
- Solution: The RV81(1 1/4") has a maximum capacity of 2,500,000 Btu/h. The pressure drop at a flow of 2,000,000 Btu/h is 0.66" w.c. The RV81 (1 1/4") is the correct regulator to use with this application. The pressure drop of the RV61 (1 1/4") at a flow rate of 2,000,000 Btu/h is 2.64" w.c. This is within the available differential but exceeds the recommended 50% maximum.

LEVER ACTING

For main burner and pilot load application requiring positive dead-end lockup (see Definitions page 63).

Example: To select a 325 series regulator:

- Known: Single 145,000 Btu/h burner; pipe size 1/2"; inlet pressure 2 psi; outlet pressure 7" w.c.
- Solution: The 325-3's pressure drop at a flow rate of 145,000 Btu/h is 7" w.c., well below the available differential of 1 3/4 psi. However, the Maximum Individual Load for the 325-3 is only 100,000 Btu/h. The 325-5 (1/2") is the correct regulator to use with this application.

BALANCED VALVE

For main burner and pilot load application requiring a lockup type regulator or zero governor usage (see Definitions page 63).

Example: To select a 210 or R/RS series regulator:

- Known: Desired flow rate 6,000,000 Btu/h; pipe size 1 1/2"; inlet pressure 1 psi; outlet pressure 9" w.c.
- Solution: The 210E (1 1/2") has a maximum capacity of 10,000,000 Btu/h. The 210D (1 1/2") has a capacity of 6,000,000 Btu/h. Therefore, the 210E (1 1/2") will give you the desired outlet pressure of 9" w.c. and is the correct regulator to use for the application.

MAXITROL®

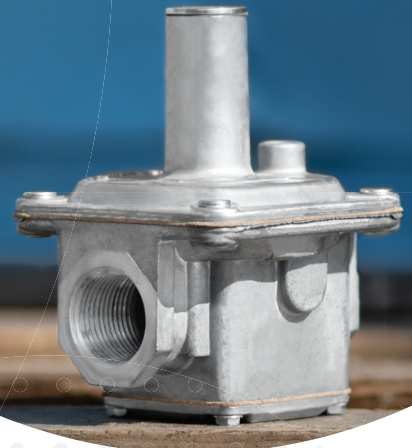

SOCIAL MEDIA >
LET'S CONNECT

Follow us for updates, interesting articles,
company news and product information.



Maxitrol Company

23555 Telegraph Road
Southfield, MI 48033
USA

T: (+1) 248 356-1400
infoNA@maxitrol.com

Maxitrol GmbH & Co. KG

Valleys Innovation Centre
Navigation Park
Abercynon CF45 4SN
United Kingdom

T: (+44) 1443 742-755
M: (+44) 7866 492-261
infoEU@maxitrol.com

Maxitrol GmbH & Co. KG

Warnstedter Str. 3
06502 Thale
Germany

T: (+49) 3947 400-0
infoEU@maxitrol.com

Maxitrol GmbH & Co. KG

Industriestr. 1
48308 Senden
Germany

T: (+49) 2597 9632-0
senden@maxitrol.com